

WVA : 29108, 29087, 29042  
 29202, 29059, 29061, 29105, 29108  
 GRANTEX No: PAS - 625

**MERCEDES Models:**

Actros, Axor,  
**O.E. No:**  
 000 421 05 10  
**000 421 07 10**  
**O.E. No:**  
 09.801.06.36.0

**SAF**

**O.E. No:**  
 3.057.0077.00

**IVECO Models: Stralis**

Trakker, EuroCargo  
**O.E. No:**  
 299 2348

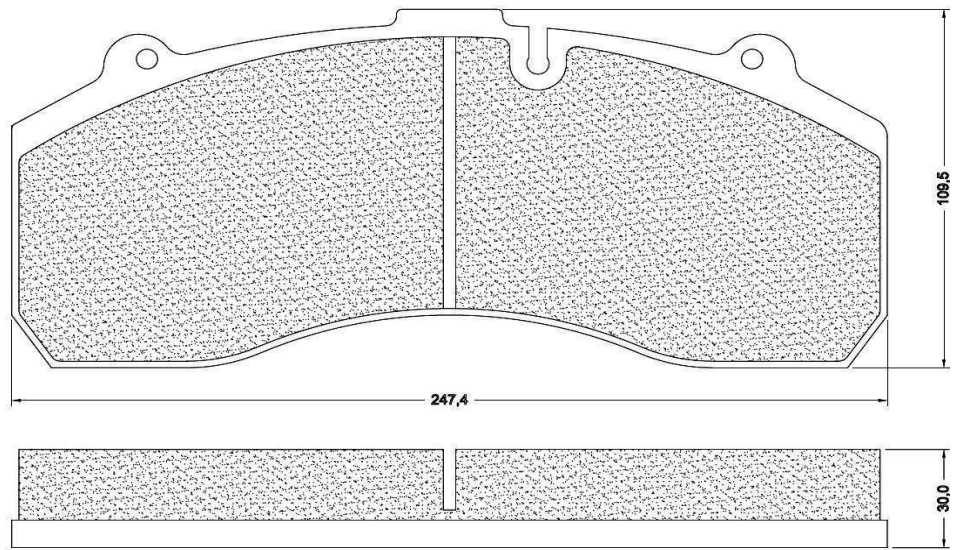

A:247,4 mm B:109,5 mm C:30 mm

**KIT**

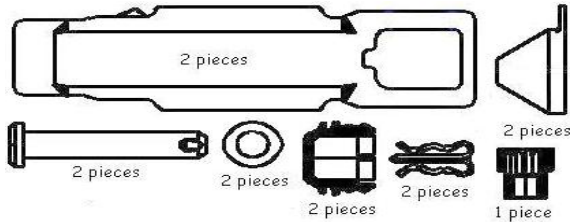

GRANTEX No.: ACK-101D

**SPRINGS**



GRANTEX No.: ACC-801A

**SENSORS - WEAR INDICATORS**

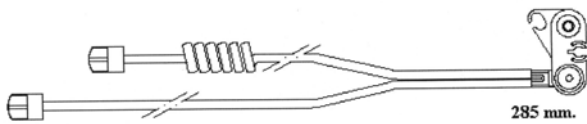

GRANTEX No.: ACC-433  
 O.E. No.: 1903651/96990 0253  
**MODELS: IVECO** EUROCARGO, EUROSTAR, EUROTECH, TRAKKER, EUROTECH CURSOR, STRALIS, EUROTRAKKER

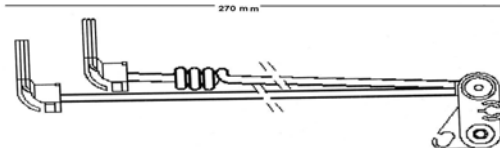

GRANTEX No.: ACC-453  
 O.E. No.: 1903651/96990 0253  
**MODELS: SCANIA** SERIE 4-94, SERIE 4-114, SERIE 4-124, SERIE 4-144, SERIE P-R-T

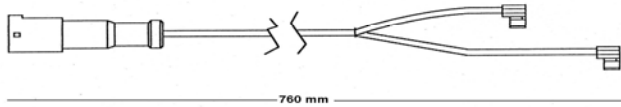

GRANTEX No.: ACC-454  
 O.E. No.: Z0008242  
**MODELS: KN, BPW, SAF-SAUER, GENERAL TRAILERS, SAE DUPILLIER, SAMRO, TRAILOR, FRUEHAUF, SMB**

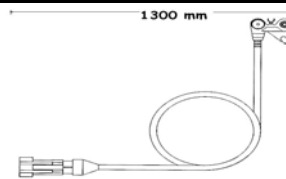

GRANTEX No.: ACC-432  
 O.E. No.: -  
**MODELS: IVECO** EUROCARGO, EUROSTAR, EUROTECH, EUROTECH CURSOR, STRALIS, EUROTRAKKER, TRAKKER



GRANTEX No.: ACC-455  
 O.E. No.: Z0008241, 969900288  
**MODELS: TRAILERS 19,5" KN SB 7000**

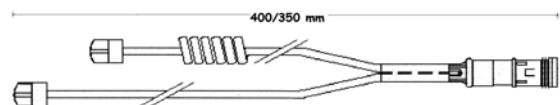

GRANTEX No.: ACC-437  
 O.E. No.: 81508226017  
**MODELS: MAN TGA 1994**

### SENSORS - WEAR INDICATORS

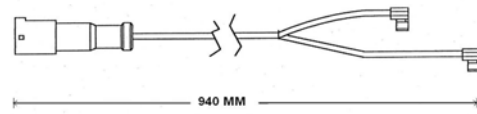
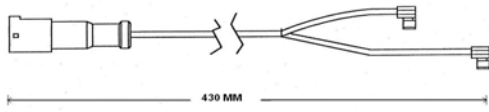

**GRANTEX No.:** ACC-467

**O.E. No.:**

**MODELS:** TRAILERS 22,5" KN SB 7000

**GRANTEX No.:** ACC-466

**O.E. No.:**

**MODELS:** TRAILERS 22,5" KN SB 7000

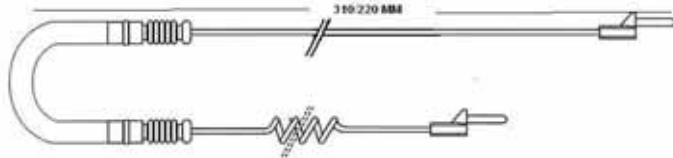

**GRANTEX No.:** ACC-465

**O.E. No.:** 82135210

**MODELS:** PERROT BREMSEN, BOVA FUTURA, DENNIS, NEOPLAN,  
VAN HOOL, SETRA

Manufacturers' names and numbers are used for reference purposes only and do not imply any connection with the original manufacturers. All parts in this catalogue are made on behalf of GRANTEX S.A. and are not original parts.

**GRANTEX S.A.** Terma Orpheos, Aegaleo 122 41, Athens - Greece, Tel: +30 210 3473869, Fax: +30 210 3472185, email: [info@grantex.gr](mailto:info@grantex.gr), url: [www.grantex.gr](http://www.grantex.gr)

**WVA : 29095,29094,29093**  
**GRANTEX No: PAS - 624**

**MERCEDES Models:**

Atego 1215 - 1528

Tourino O 510

**O.E. No:**

000 421 07 10

002 420 78 20

002 420 79 20

**SAF**

**O.E. No:**

3.057.0078.00

**MAN Models:**

M 2000

**O.E. No:**

81 50820 5017

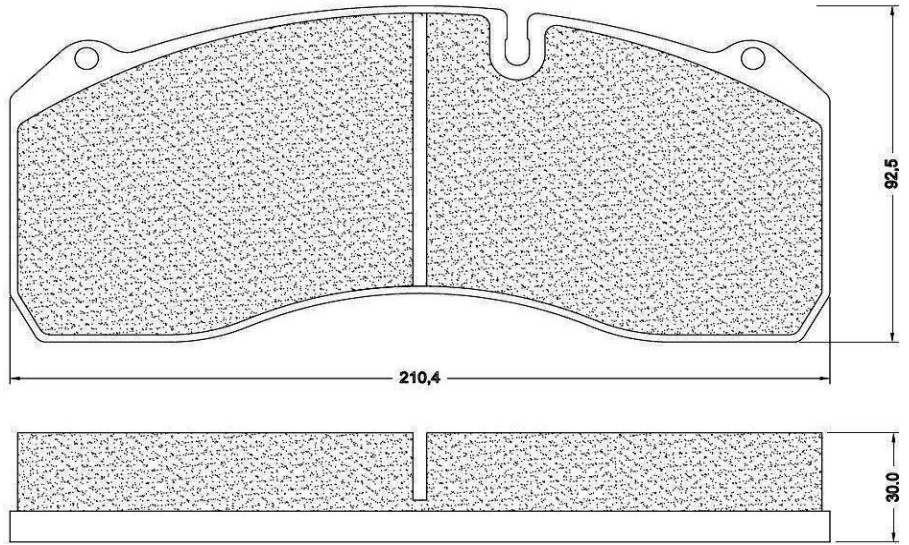

A:210,4 mm B:92,5 mm C:30 mm

**KIT**

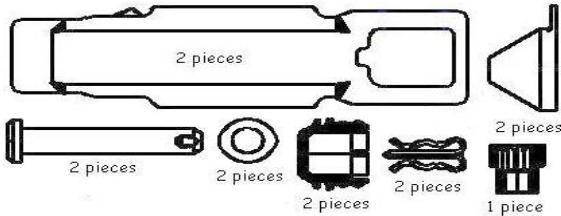

**GRANTEX No.: ACK-101D**

**SPRINGS**



**GRANTEX No.: ACC-801A**

**SENSORS - WEAR INDICATORS**

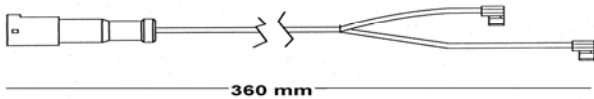

**GRANTEX No.: ACC-455**

**O.E. No.: Z0008241/969900288**

**MODELS: BPW, AXLE, SAF, SKRB, SKH**



**GRANTEX No.: ACC-413**

**O.E. No.: 1908231**

**MODELS: IVECO 2 SERIES**

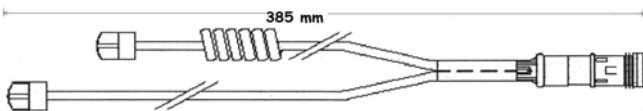

**GRANTEX No.: ACC-438**

**O.E. No.: 8150226011**

**MODELS: MAN M2000 SERIES**

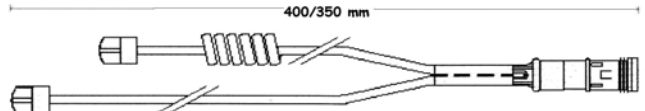

**GRANTEX No.: ACC-437**

**O.E. No.: 81508226017**

**MODELS: MAN A SERIES, L SERIES, M SERIES, KN SV 6503**

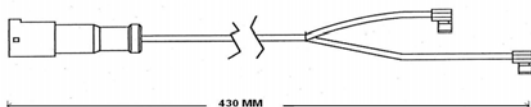

**GRANTEX No.: ACC-467**

**O.E. No.:**

**MODELS: TRAILERS 22,5" KN SB 7000**

**GRANTEX No.:**

**O.E. No.:**

**MODELS:**

Manufacturers' names and numbers are used for reference purposes only and do not imply any connection with the original manufacturers. All parts in this catalogue are made on behalf of GRANTEX S.A. and are not original parts.

WVA : 29115, 29148  
 GRANTEX No: PAS - 623

**MERCEDES Models:**

Atego 712 - 1022

**O.E. No:**

000 421 10 10

000 421 12 10

000 421 07 10

001 421 25 10

003 420 11 20

003 420 12 20

**MAN Models:**

TGL

**O.E. No:**

81 50820 5085

81 50820 6054

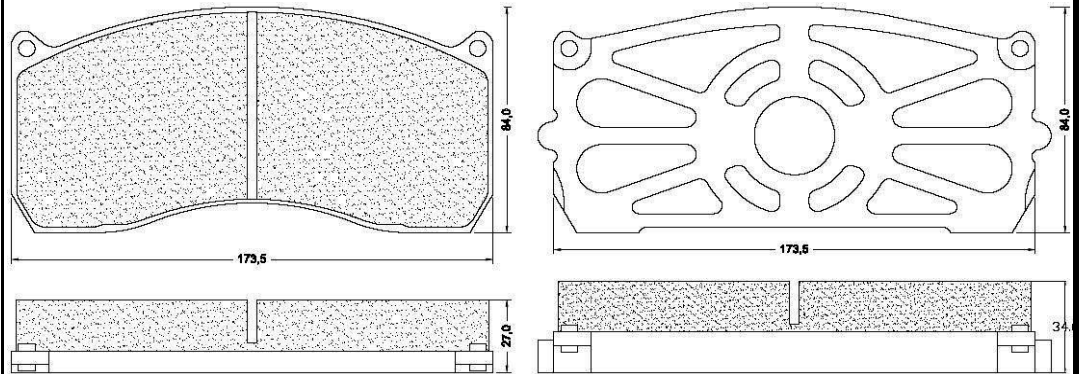

A:173,5 mm B:84 mm C:27 / 34 mm

**KIT**

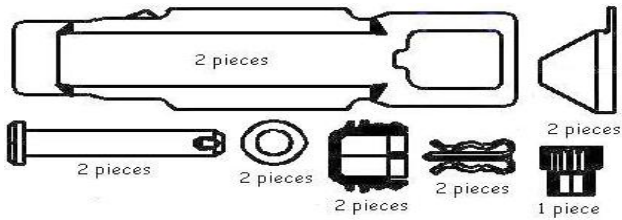

GRANTEX No.: ACK-101D

**SPRINGS**

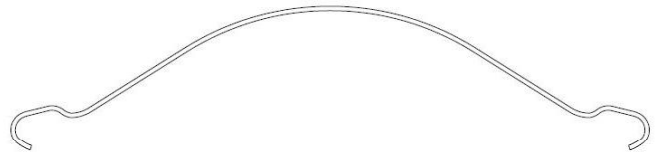

GRANTEX No.: ACC-806

Manufacturers' names and numbers are used for reference purposes only and do not imply any connection with the original manufacturers. All parts in this catalogue are made on behalf of GRANTEX S.A. and are not original parts.

WVA : 29167  
GRANTEX No: PAS - 610

BPW O.E. No:  
05.092.90.07.0  
05.362.70.02.0  
09.801.02.92.0  
09.801.06.36.0  
09.801.06.96.0

Replaces:

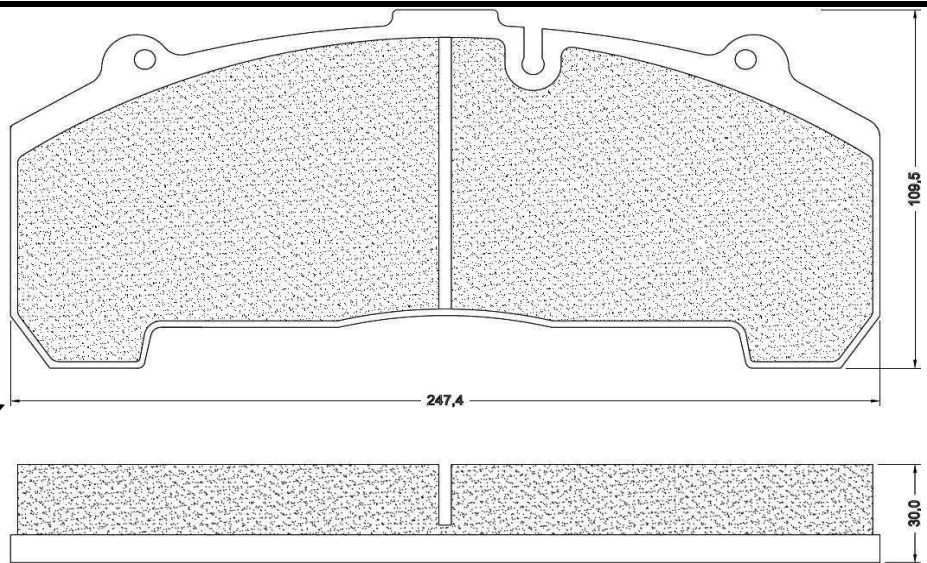
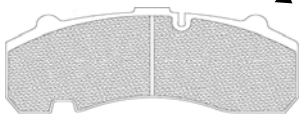

A:247,4 mm B:109,5 mm C:30 mm

### KIT

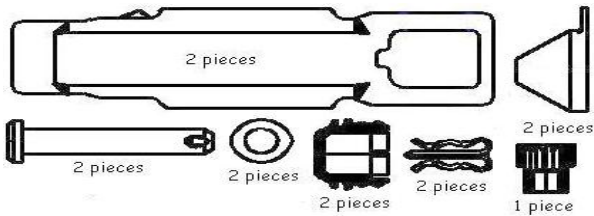

GRANTEX No.: ACK-101D

### SPRING



GRANTEX No.: ACC-801A

### SENSORS - WEAR INDICATORS

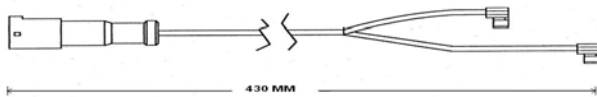

GRANTEX No.: ACC-467

O.E. No.:

MODELS: TRAILERS 22,5" KN SB 4345



GRANTEX No.: ACC-466

O.E. No.:

MODELS: TRAILERS 22,5" KN SB 3745

Manufacturers' names and numbers are used for reference purposes only and do not imply any connection with the original manufacturers. All parts in this catalogue are made on behalf of GRANTEX S.A. and are not original parts.

WVA : 29165  
GRANTEX No: PAS - 608

BPW O.E. No:  
05.092.90.04.0  
05.092.90.05.0  
05.092.90.10.0  
09.801.06.21.0  
09.801.07.09.0

Replaces:

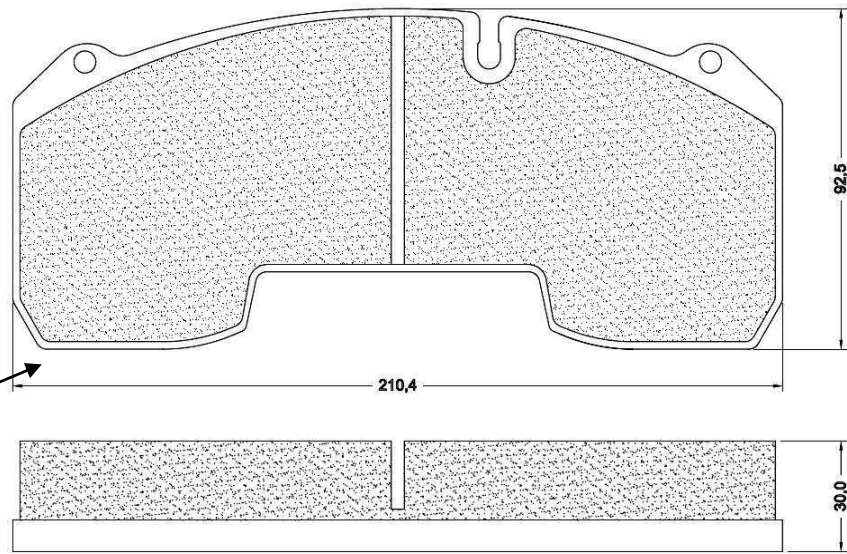
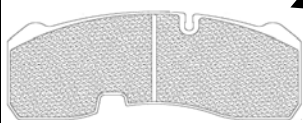

A:210,4 mm B:92,5 mm C:30 mm

### KIT

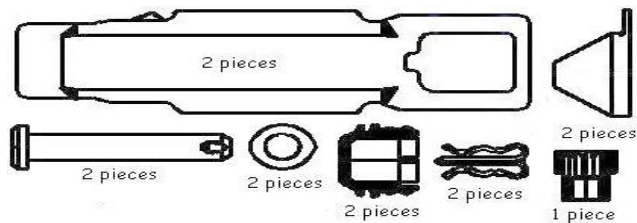

GRANTEX No.: ACK-101D

### SPRING



GRANTEX No.: ACC-801A

### SENSORS - WEAR INDICATORS

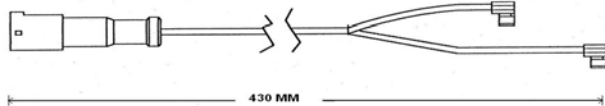

GRANTEX No.: ACC-467

O.E. No.:

MODELS: TRAILERS 22,5" KN SB 4345

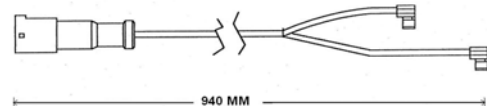

GRANTEX No.: ACC-466

O.E. No.:

MODELS: TRAILERS 22,5" KN SB 3745

Manufacturers' names and numbers are used for reference purposes only and do not imply any connection with the original manufacturers. All parts in this catalogue are made on behalf of GRANTEX S.A. and are not original parts.

WVA : 29171, 29158  
GRANTEX No: PAS - 609

BPW O.E. No:  
05.092.90.06.0

Replaces:

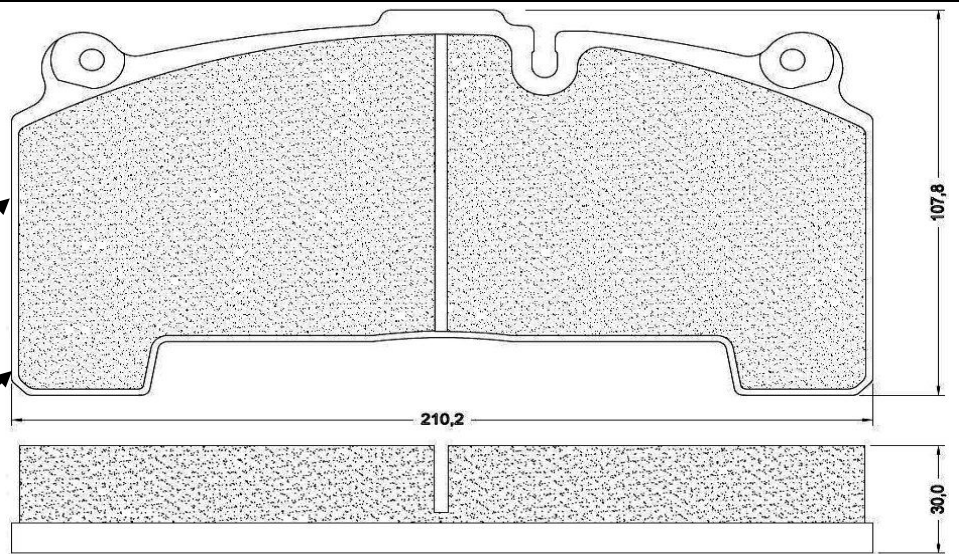

A:210,2 mm B:107,8 mm C:30 mm

### KIT

### SPRING

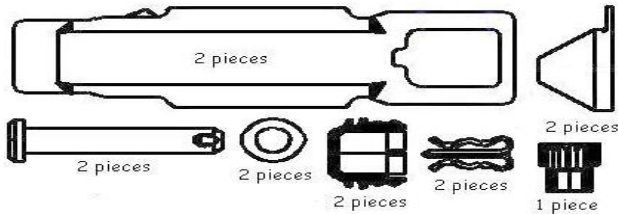

GRANTEX No.: ACK-101D

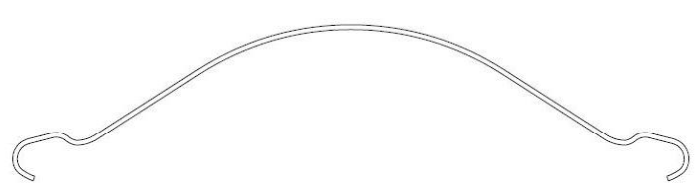

GRANTEX No.: ACC-813

### SENSORS - WEAR INDICATORS

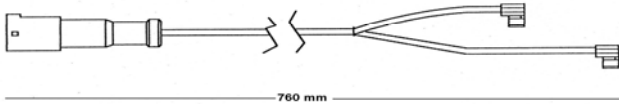

GRANTEX No.: ACC-454

O.E. No.: Z0008242

MODELS: BPW, SAF 19,5" KN SB-SN6/SB-SN-SK7

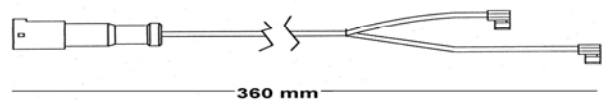

GRANTEX No.: ACC-455

O.E. No.: Z0008241/969900288

MODELS: BPW AXLE 22,5" KN SN6/SN7/SK7

Manufacturers' names and numbers are used for reference purposes only and do not imply any connection with the original manufacturers. All parts in this catalogue are made on behalf of GRANTEX S.A. and are not original parts.

**MER D - 3**  
**VVA : 29030, 29113, 29083**  
**GRANTEX No: PAS - 448**

**MERCEDES Models:**  
 O 340, O 350, O 404

**O.E. No:**  
 002 420 08 20  
 000 421 07 10

**MAN Models:**  
 F 2000, M 2000, F 90

**O.E. No:**  
 81 50820 5047  
 81 50820 6014

**RENAULT Models:**  
 Magnum, Premium

**O.E. No:**  
 5001 823 000

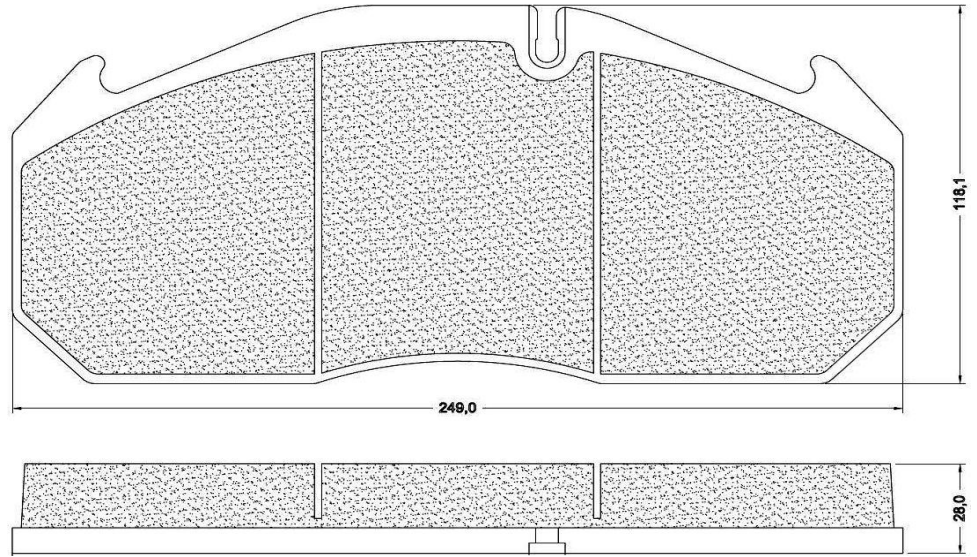

A:249 mm B:118,1 mm C:28 mm

### KIT

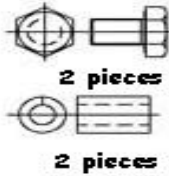

2 pieces

2 pieces

**GRANTEX No.:** ACK-105

### SPRING



4 pieces

**GRANTEX No.:** ACC-804

### SENSORS - WEAR INDICATORS

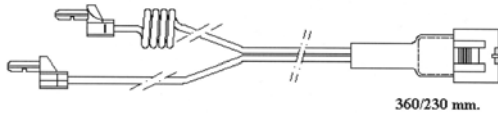

360/230 mm.

**GRANTEX No.:** ACC 416

**O.E. No.:** 5001822987, 68320902

**MODELS:** HEULIEZ, RENAULT AGORA, MAGNUM-AE  
 RENAULT FR-BUS, PREMIUM, R-MAJOR

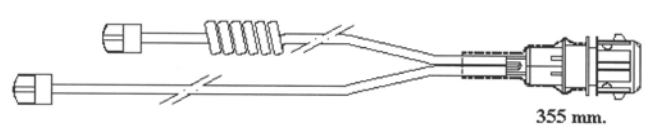

355 mm.

**GRANTEX No.:** ACC-419

**O.E. No.:** 5001834075/96990 0255

**MODELS:** HEULIEZ, RENAULT AGORA, PREMIUM, R-MAJOR,  
 RENAULT FR-BUS, MAGNUM AE

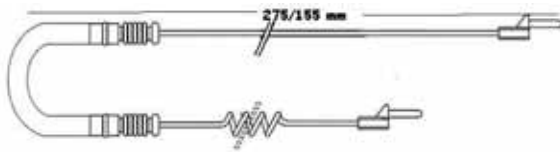

275/155 mm

**GRANTEX No.:** ACC-415

**O.E. No.:** 3565400017/96990 0172

**MODELS:** MERCEDES O-SERIES, INTEGRO (0 550),  
 S-SERIES

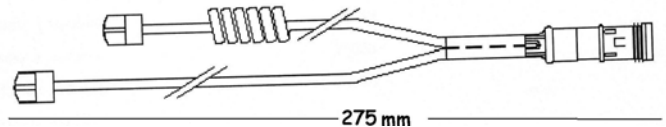

275 mm

**GRANTEX No.:** ACC-451

**O.E. No.:** 81508226013

**MODELS:** MAN, MERITOR,  
 RUBERY OWEN-ROCKWELL

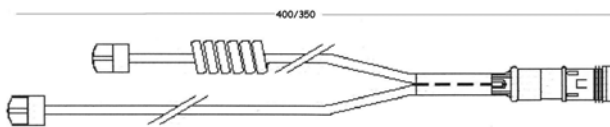

400/350

**GRANTEX No.:** ACC-437

**O.E. No.:** 81508226017/96990 0243

**MODELS:** MAN NG/NL/NU-SERIES

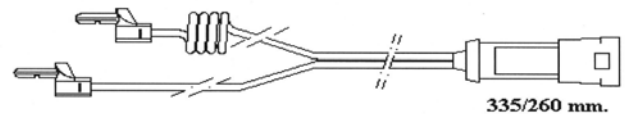

335/260 mm.





**GRANTEX No.:** ACC-417

**O.E. No.:** 81508110004/96990 0176

**MODELS:** MAN, MERCEDES, AUWARTER, KASSBOHRER,  
 SETRA BUS 5300 NL CITY

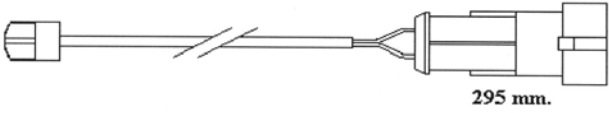

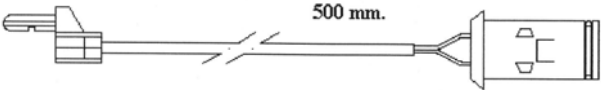
### SENSORS - WEAR INDICATORS

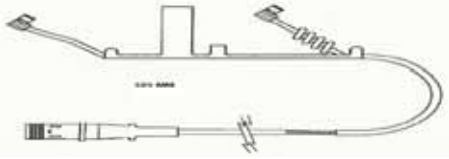
 <p>295 mm.</p>	 <p>380 MM</p>
<p><b>GRANTEX No.:</b> ACC-420  <b>O.E. No.:</b> 1908407/96990 0248  <b>MODELS:</b> IVECO DAILY, EUROCARGO</p>	<p><b>GRANTEX No.:</b> ACC-458  <b>O.E. No.:</b> 68324613  <b>MODELS:</b> IVECO IRIS BUS, KAROSA</p>
 <p>500 mm.</p>	 <p>500 MM</p>
<p><b>GRANTEX No.:</b> ACC-430  <b>O.E. No.:</b> 9801907942  <b>MODELS:</b> IVECO, EUROCARGO, MAGIRUS</p>	<p><b>GRANTEX No.:</b> ACC-469  <b>O.E. No.:</b> 4044197285006  <b>MODELS:</b> IVECO EUROCARGO</p>
 <p>500 mm.</p>	
<p><b>GRANTEX No.:</b> ACC-468  <b>O.E. No.:</b> 4044197267194  <b>MODELS:</b> MAN F90 - F2000 - M2000 - EL SERIES, MAN LIONSTAR (BUS), SETRA S300 BUS, VAN HOOL SERIES</p>	<p><b>GRANTEX No.:</b>  <b>O.E. No.:</b>  <b>MODELS:</b></p>

Manufacturers' names and numbers are used for reference purposes only and do not imply any connection with the original manufacturers. All parts in this catalogue are made on behalf of GRANTEX S.A. and are not original parts.

MER D - LISA  
WVA : 29090  
GRANTEX No: PAS - 502

### RENAULT TRUCKS

**Models:**  
Magnum, Premium  
**O.E. No:**  
5001 846 034

### VOLVO

**Models:**  
B 12  
**O.E. No:**  
3 093 919  
8 550 611-1  
20850194

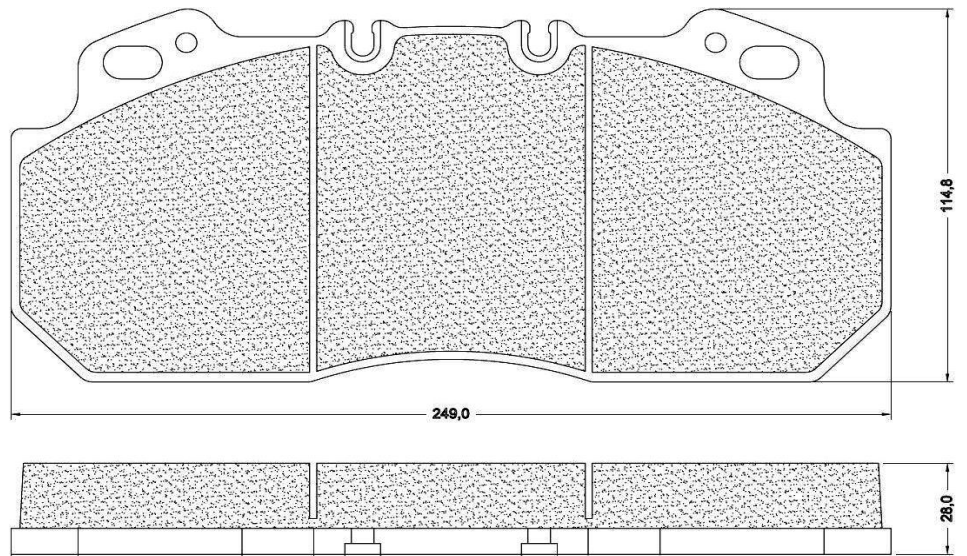

A:249 mm B:114,8 mm C:28 mm

### KIT

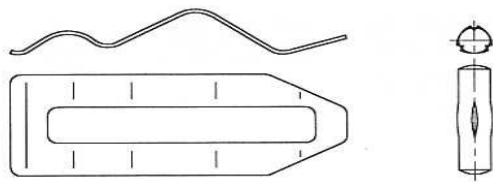

GRANTEX No.: ACK-103

### SPRING



GRANTEX No.: ACC-802

### SENSORS - WEAR INDICATORS



GRANTEX No.: ACC-419  
O.E. No.: 5001834075/96990 0255  
**MODELS:** RENAULT TRUCKS, PREMIUM,  
MAGNUM-AE

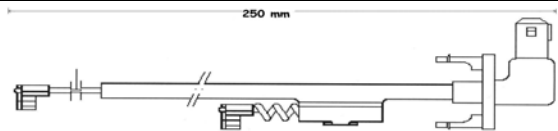

GRANTEX No.: ACC-424  
O.E. No.: 5001831161/96990 0252  
**MODELS:** RENAULT, MAGNUM-AE, PREMIUM, BUSES



GRANTEX No.: ACC-457  
O.E. No.: -  
**MODELS:** IRISBUS KEULIEZ, RENAULT AGORA  
MERITOR, RENAULT MAGNUM-AE, PREMIUM

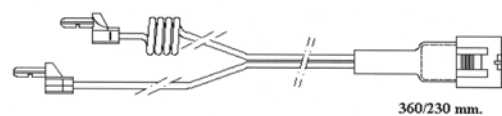

GRANTEX No.: ACC-416  
O.E. No.: 68320902, 5001822987  
**MODELS:** RENAULT AE

Manufacturers' names and numbers are used for reference purposes only and do not imply any connection with the original manufacturers. All parts in this catalogue are made on behalf of GRANTEX S.A. and are not original parts.

**MER D-DUCO**  
**WVA : 29125**  
**GRANTEX No: PAS - 547**

**VOLVO**  
**Models:**  
 FM 9, FH 12, FH 16  
 FL 180 - 250  
**O.E. No:**  
 209 188 91  
 207 680 92  
 3 095 396

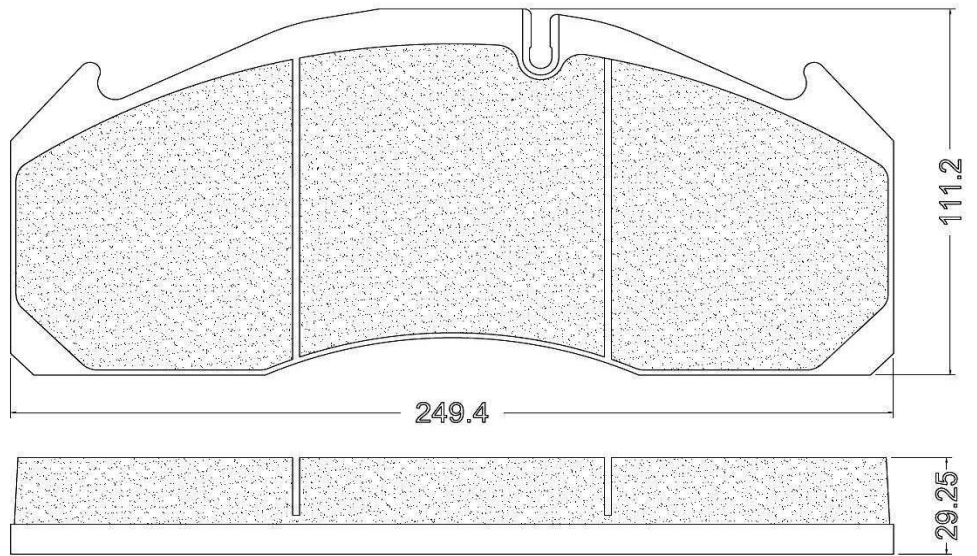

**A:249,4 mm B:111,2 mm C:29,25 mm**

### KIT

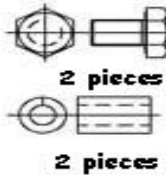

**GRANTEX No.: ACK-105**

### SPRINGS

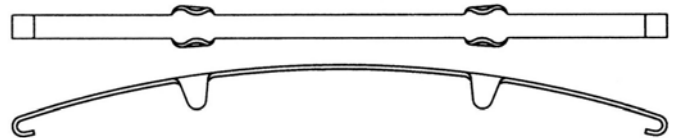

**GRANTEX No.: ACC-817**

### SENSORS - WEAR INDICATORS

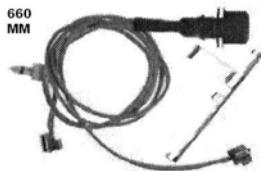

**GRANTEX No.: ACC-470**

**O.E. No.:**  
**MODELS: RENAULT 2000 -**

**GRANTEX No.:**

**O.E. No.:**  
**MODELS:**

Manufacturers' names and numbers are used for reference purposes only and do not imply any connection with the original manufacturers. All parts in this catalogue are made on behalf of GRANTEX S.A. and are not original parts.

**MER D-ELSA 2**  
**WVA : 29131**  
**GRANTEX No: PAS - 557**

**MERITOR**  
**RUBERY - OWEN**  
**ROCKWELL**

**MAN Models:**  
 TGA - 18...

**O.E. No:**  
 81 50820 5072  
 81 50820 5080  
 81 50820 6041  
 81 50820 6051

**RENAULT Models:**  
 Magnum, Premium

**O.E. No:**  
 5001 855 646  
 5001 020 312  
 5006 028 410

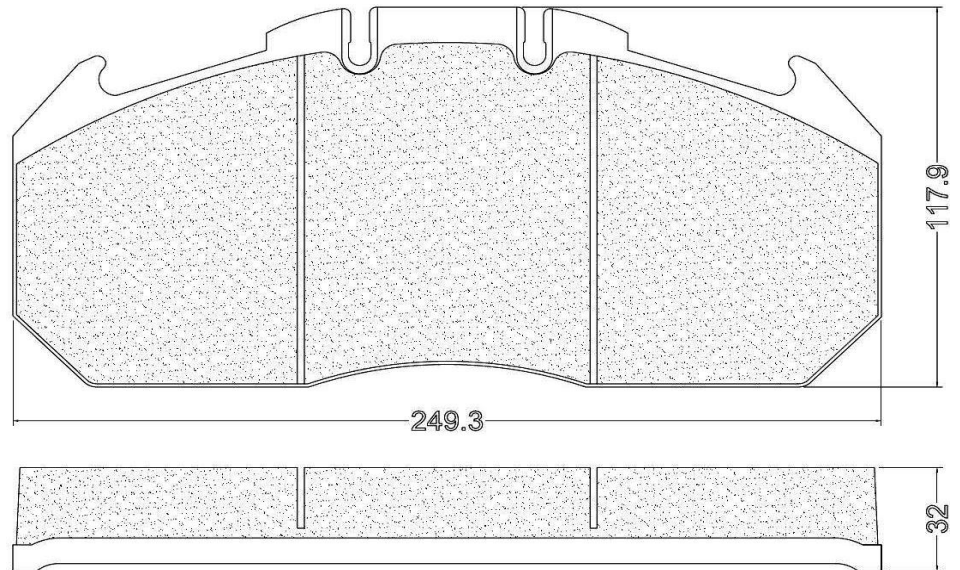

**A:249,3 mm B:117,9 mm C:32 mm**

### KIT

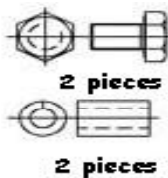

**GRANTEX No.:** ACK-105

### SPRING



**GRANTEX No.:** ACC-804

### SENSORS - WEAR INDICATORS

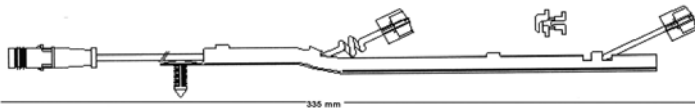

**GRANTEX No.:** ACC-452  
**O.E. No.:** 68324072/96990 0324  
**MODELS:** MAN TGA



**GRANTEX No.:** ACC-458  
**O.E. No.:** 68324613  
**MODELS:** RENAULT PREMIUM, MAGNUM E.TECH, CENTROLINER, CITELIS, MAGNUM AE, RENAULT AGORA, RENAULT FR-BUS

Manufacturers' names and numbers are used for reference purposes only and do not imply any connection with the original manufacturers. All parts in this catalogue are made on behalf of GRANTEX S.A. and are not original parts.

MER ELSA 225-3  
WVA : 29174  
GRANTEX No: PAS - 631

### RENAULT TRUCKS

Models:  
Magnum DXi  
O.E. No:  
5001 864 363

### VOLVO

O.E. No:  
205 687 11

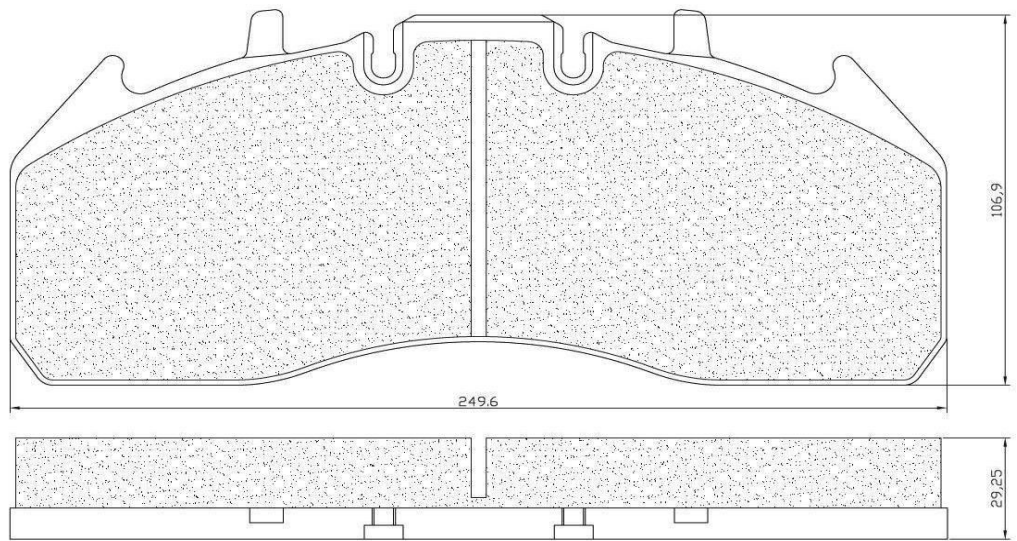

A:249,6 mm B:106,9 mm C:29,25 mm

### KIT

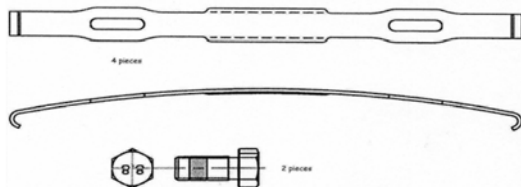

GRANTEX No.: ACK-109

### SPRINGS

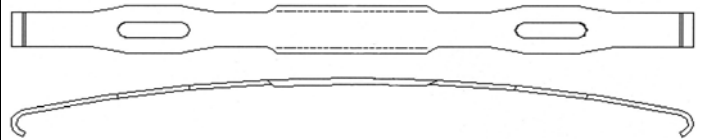

GRANTEX No.: ACC-814

### SENSORS - WEAR INDICATORS

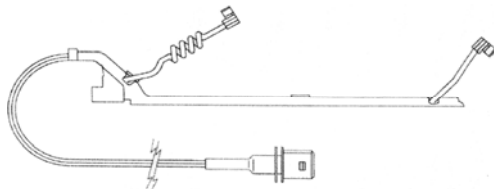

GRANTEX No.: ACC-459  
O.E. No.: 68325408/969900282

MODELS: RENAULT MAGNUM Dxi, PREMIUM II,  
VOLVO TRUCKS



GRANTEX No.: ACC-458  
O.E. No.: 68324613  
MODELS: RENAULT PREMIUM DX 12/13

Manufacturers' names and numbers are used for reference purposes only and do not imply any connection with the original manufacturers. All parts in this catalogue are made on behalf of GRANTEX S.A. and are not original parts.

MER VGT 195  
WVA : 29169  
GRANTEX No: PAS - 617

VOLVO  
O.E. No:  
205 687 13

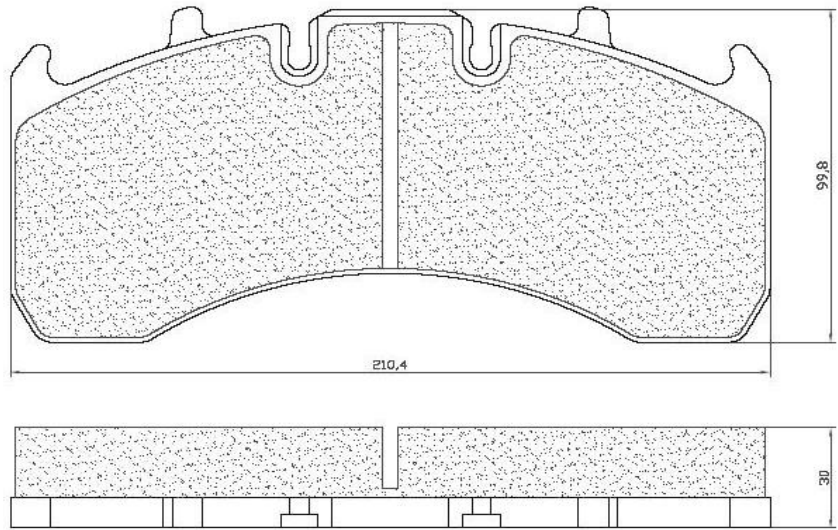

A:210,4 mm B:99,8 mm C:30 mm

### KIT

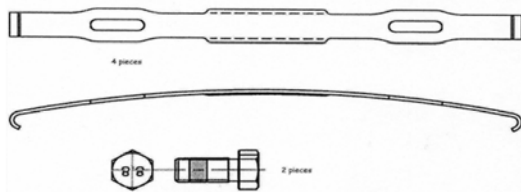

GRANTEX No.: ACK-109

### SPRINGS

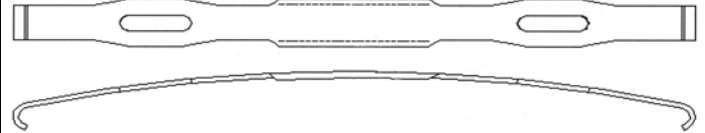

GRANTEX No.: ACC-814

### SENSORS - WEAR INDICATORS

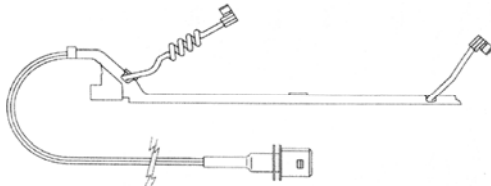

GRANTEX No.: ACC-459

O.E. No.: 68325408/969900282

MODELS: **RENAULT** MAGNUM Dxi, PREMIUM II,  
VOLVO TRUCKS

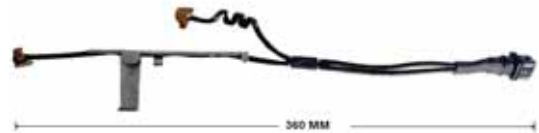

GRANTEX No.: ACC-458

O.E. No.: 68324613

MODELS: **RENAULT** PREMIUM DX 12/13

Manufacturers' names and numbers are used for reference purposes only and do not imply any connection with the original manufacturers. All parts in this catalogue are made on behalf of GRANTEX S.A. and are not original parts.

MER ELSA 225-1  
WVA : 29173  
GRANTEX No: PAS - 632

### RENAULT TRUCKS

**Models:**  
Midlum 190.12-16  
Midlum 160.12  
**O.E. No:**  
5001 864 365

### VOLVO

**O.E. No:**  
205 687 12

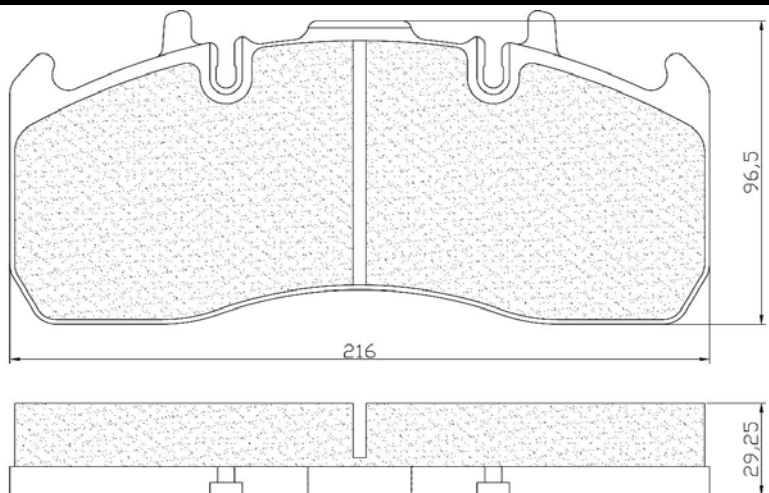

A:216 mm B:96,5 mm C:29,25 mm

### KIT

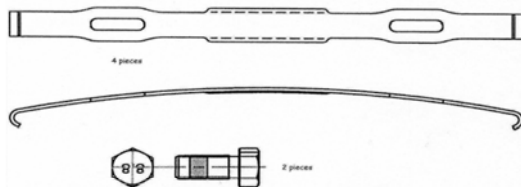

GRANTEX No.: ACK-109

### SPRINGS



GRANTEX No.: ACC-814

### SENSORS - WEAR INDICATORS

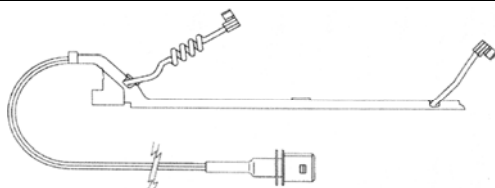

GRANTEX No.: ACC-459  
O.E. No.: 68325408/969900282

**MODELS:** RENAULT MAGNUM Dxi, PREMIUM II,  
VOLVO TRUCKS



GRANTEX No.: ACC-458

O.E. No.: 68324613

**MODELS:** RENAULT PREMIUM

Manufacturers' names and numbers are used for reference purposes only and do not imply any connection with the original manufacturers. All parts in this catalogue are made on behalf of GRANTEX S.A. and are not original parts.

Wb PAN 17  
WVA : 29088  
GRANTEX No: PAS - 510

**RENAULT Models:**

Midlum 160 - 220  
O.E. No: 5010 848 607

**MAN Models:**

000 421 07 10  
O.E. No: 8150820 5023  
81 50820 5029  
81 50820 5025

**DAF Models:** LF 45

O.E. No: 143 6901

**IVECO Models:**

EuroCargo 120 - ...  
Midlum 135 - 210  
O.E. No: 190 6467

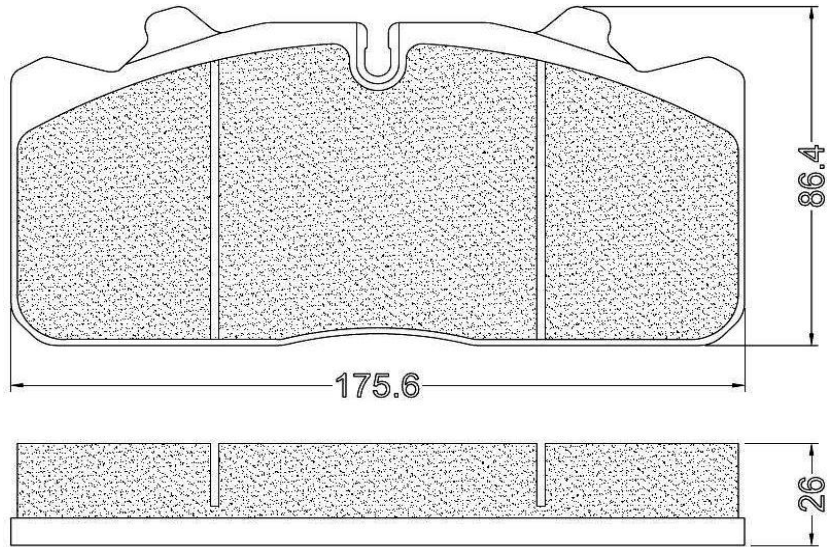

A:175,6 mm B:86,4 mm C:26 mm

**KIT**

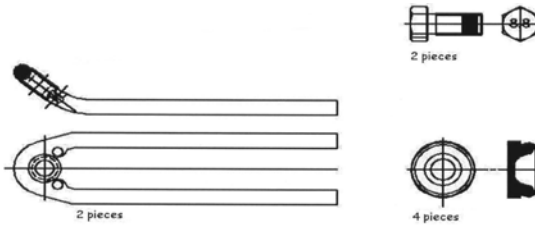

GRANTEX No.: ACK-106

**SPRINGS**

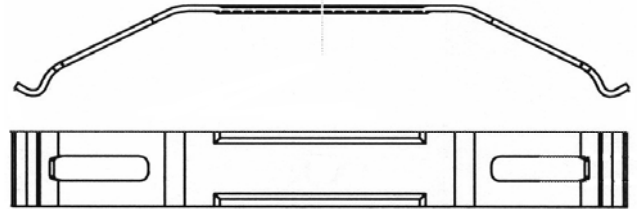

GRANTEX No.: ACC-807A

**SENSORS - WEAR INDICATORS**

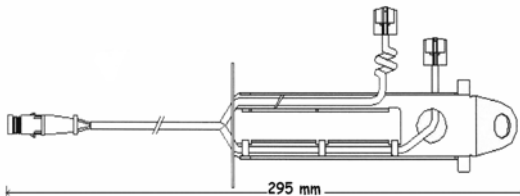

GRANTEX No.: ACC-450  
O.E. No.: 81508226014/96990 0244  
MODELS: MAN L 2000/M 2000, L 2000

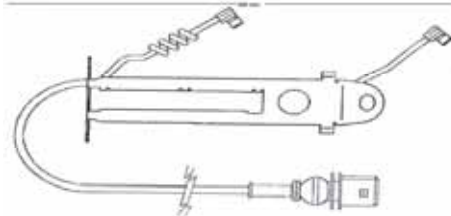

GRANTEX No.: ACC-445  
O.E. No.: 5010848607  
MODELS: RENAULT MIDLUM

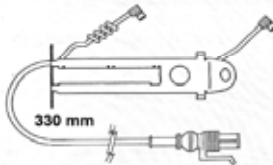

GRANTEX No.: ACC-472  
O.E. No.: 4044197247202  
MODELS: DAF LF 45 SERIES

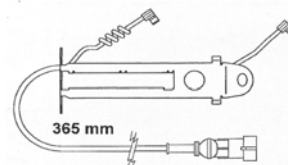

GRANTEX No.: ACC-471  
O.E. No.: 4044197228669  
MODELS: IVECO EUROCARGO 120EL

Manufacturers' names and numbers are used for reference purposes only and do not imply any connection with the original manufacturers. All parts in this catalogue are made on behalf of GRANTEX S.A. and are not original parts.



Wb PAN 22-1  
WVA : 29162  
GRANTEX No: PAS - 606

SAF

Models:

SK RLB 9022

O.E. No:

3.057.0084.00

000 421 07 10

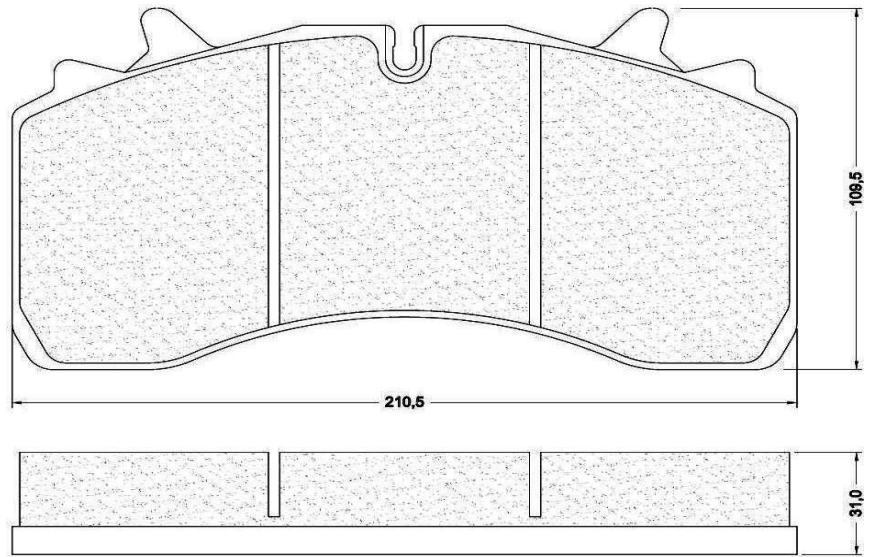

A:210.5 mm B:109,5 mm C:31 mm

### KIT

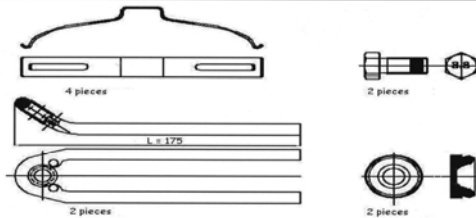

GRANTEX No.: ACK-108

### SPRINGS

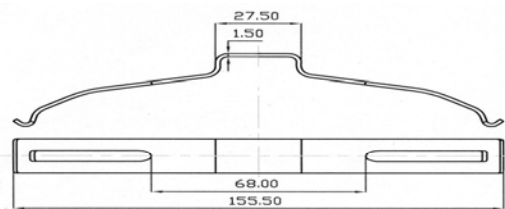

GRANTEX No.: ACC-816

### SENSORS - WEAR INDICATORS

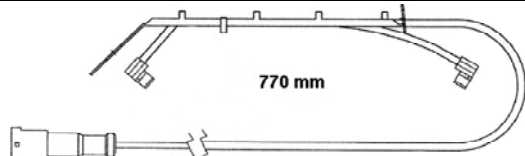

GRANTEX No.: ACC-460

O.E. No.: 3424200900

MODELS: SAF SKRLB

GRANTEX No.: -

O.E. No.: -

MODELS: -

Manufacturers' names and numbers are used for reference purposes only and do not imply any connection with the original manufacturers. All parts in this catalogue are made on behalf of GRANTEX S.A. and are not original parts.

Wb PAN 19-1  
WVA : 29159  
GRANTEX No: PAS - 552

SAF  
O.E. No:  
3.057.0080.00

DAF  
Models:  
LF 55  
O.E. No:  
162 8064

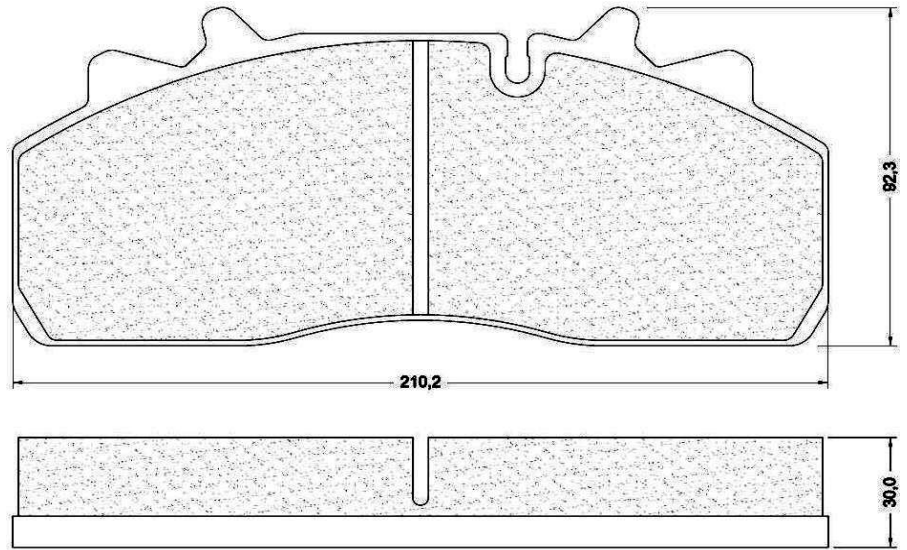

A:210,2 mm B:92,3 mm C:30 mm

### KIT

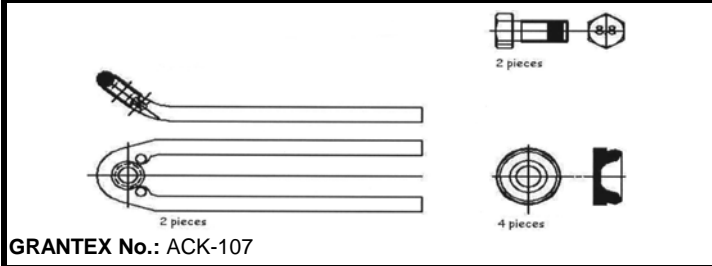

GRANTEX No.: ACK-107

### SPRING

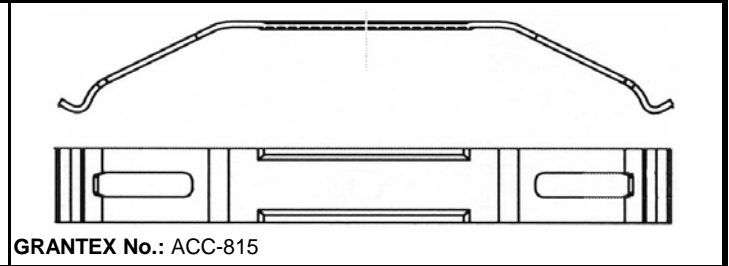

GRANTEX No.: ACC-815

### SENSORS - WEAR INDICATORS

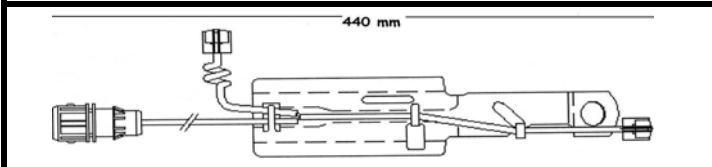

GRANTEX No.: ACC-456  
O.E. No.: 8424073096548

MODELS: RENAULT MIDLUM, PERROT BREMSEN

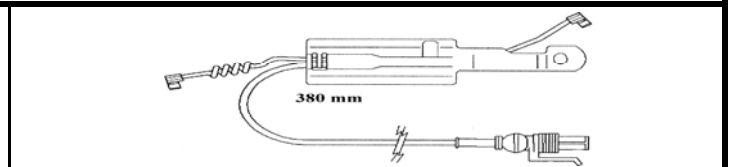

GRANTEX No.: ACC-462  
O.E. No.: 68323004

MODELS: -

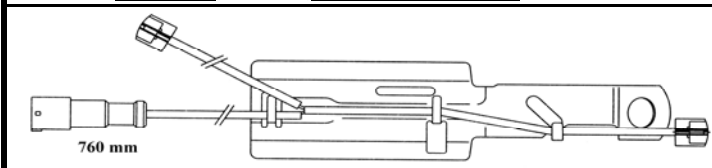

GRANTEX No.: ACC-461  
O.E. No.: 12480036  
MODELS: SAF-SAUER, WB, DAF,  
SAE DUPILLIER

GRANTEX No.: -  
O.E. No.: -  
MODELS: -

Manufacturers' names and numbers are used for reference purposes only and do not imply any connection with the original manufacturers. All parts in this catalogue are made on behalf of GRANTEX S.A. and are not original parts.

Wb PAN 19-2  
WVA : 29142  
GRANTEX No: PAS - 564

### RENAULT TRUCKS

**Models:**  
Midlum 210...  
**O.E. No:**  
000 421 07 10

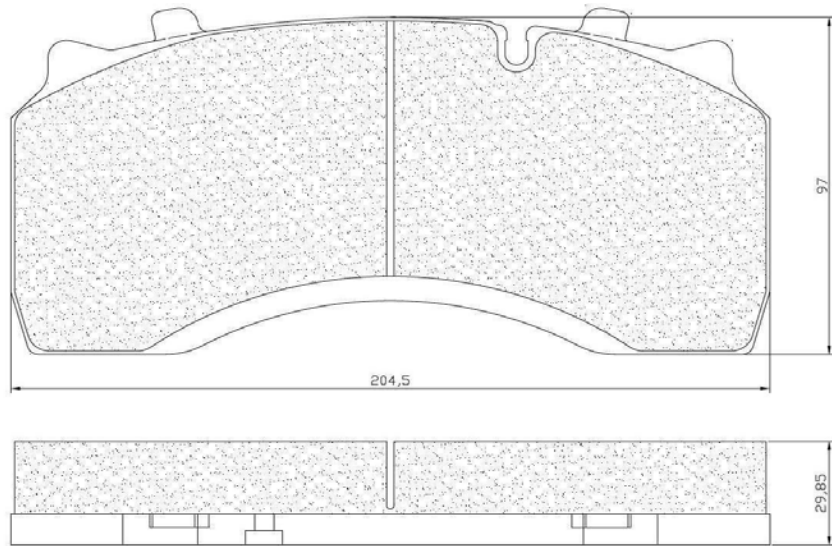

A:204,5 mm B:97 mm C:29,85 mm

### KIT

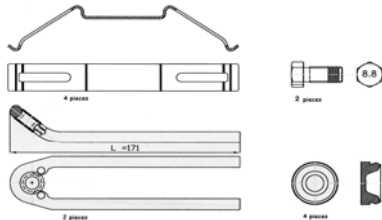

GRANTEX No.: ACK-111

### SPRINGS

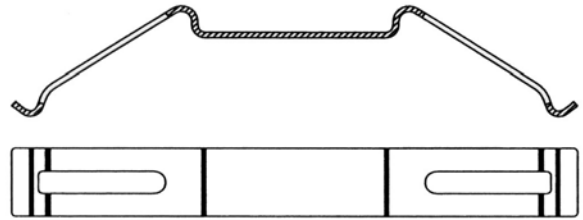

GRANTEX No.: ACC-809

### SENSORS - WEAR INDICATORS

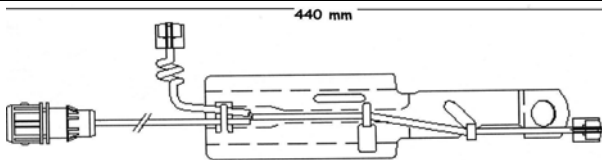

GRANTEX No.: ACC-456

O.E. No.: 8424073096548

MODELS: RENAULT MIDLUM

GRANTEX No.: -

O.E. No.: -

MODELS: -

Manufacturers' names and numbers are used for reference purposes only and do not imply any connection with the original manufacturers. All parts in this catalogue are made on behalf of GRANTEX S.A. and are not original parts.

Wb PAN 19-2  
 WVA : 29141  
 GRANTEX No: PAS - 563

DAF  
 Models:  
 LF 55...  
 O.E. No:  
 144 0504

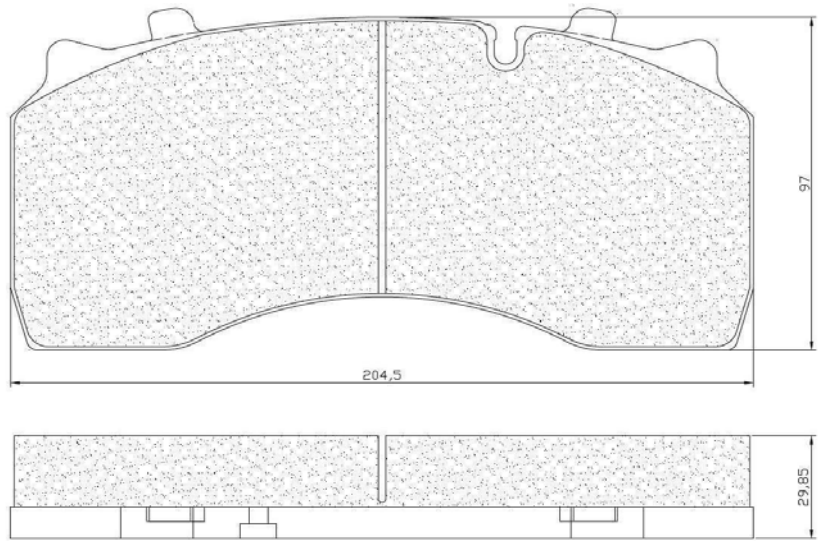

A:204,5 mm B:97 mm C:29,85 mm

### KIT

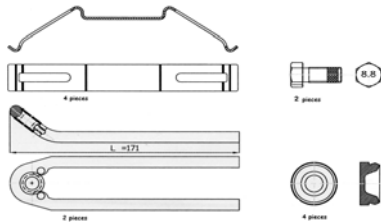

GRANTEX No.: ACK-111

### SPRING

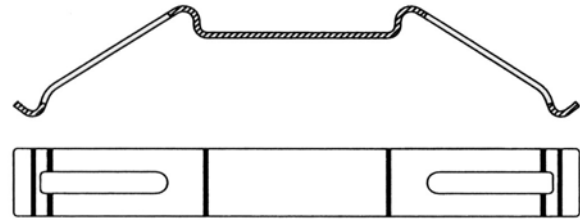

GRANTEX No.: ACC-809

### SENSORS - WEAR INDICATORS

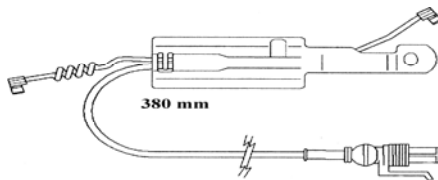

GRANTEX No.: ACC-462

O.E. No.: 68323004

MODELS: DAF, LEYLAND, DENNIS

GRANTEX No.: -

O.E. No.: -

MODELS: -

Manufacturers' names and numbers are used for reference purposes only and do not imply any connection with the original manufacturers. All parts in this catalogue are made on behalf of GRANTEX S.A. and are not original parts.

Hldx DB 22  
WVA : 29143  
GRANTEX No: PAS - 553

SAF  
O.E. No:  
3 057 3179 00

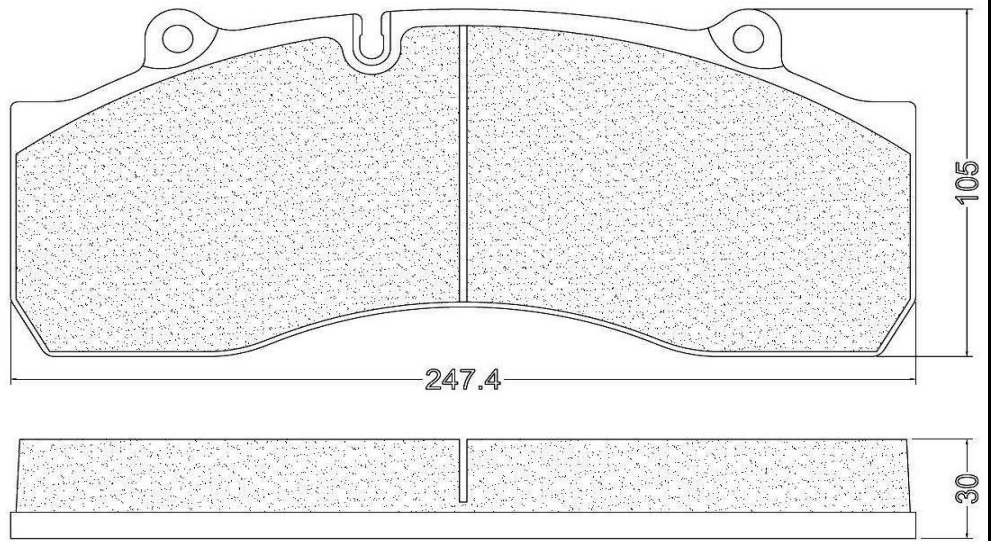

A:247,4 mm B:105 mm C:30 mm

### KIT

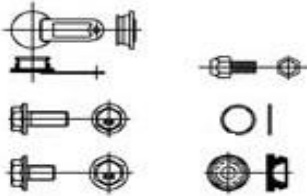

GRANTEX No.: ACK-113

### SPRING



GRANTEX No.: ACC-803

### SENSORS - WEAR INDICATORS

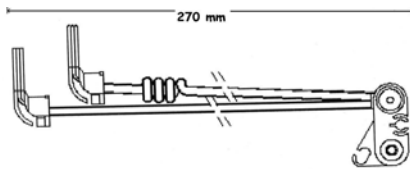

GRANTEX No.: ACC-453

O.E. No.: 1903651

MODELS: -

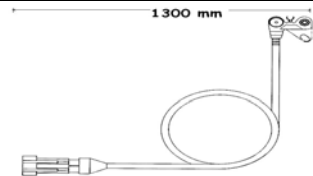

GRANTEX No.: ACC-432

O.E. No.: -

MODELS: -

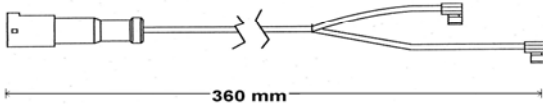

GRANTEX No.: ACC-455

O.E. No.: -

MODELS: BPW, KN SN6/SN7/SK7

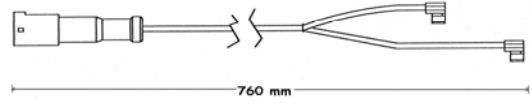

GRANTEX No.: ACC-454

O.E. No.: -

MODELS: BPW, SAF 19,5", SB-SN6/SB-SN-SK7

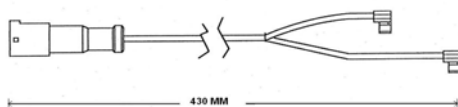

GRANTEX No.: ACC-467

O.E. No.: Z008241, 969900288

MODELS: TRAILERS 22,5", KN SB4345

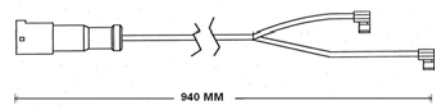

GRANTEX No.: ACC-466

O.E. No.: -

MODELS: TRAILERS 22,5", KN SV3745

Manufacturers' names and numbers are used for reference purposes only and do not imply any connection with the original manufacturers. All parts in this catalogue are made on behalf of GRANTEX S.A. and are not original parts.

Hldx DB19  
WVA : 29181  
GRANTEX No: PAS - 641

### RENAULT TRUCKS

#### Models:

Midlum 160...

Midlum 190...

Midlum 220...

#### O.E. No:

5010 598 372

### VOLVO

#### O.E. No:

207 807 88

208 449 03

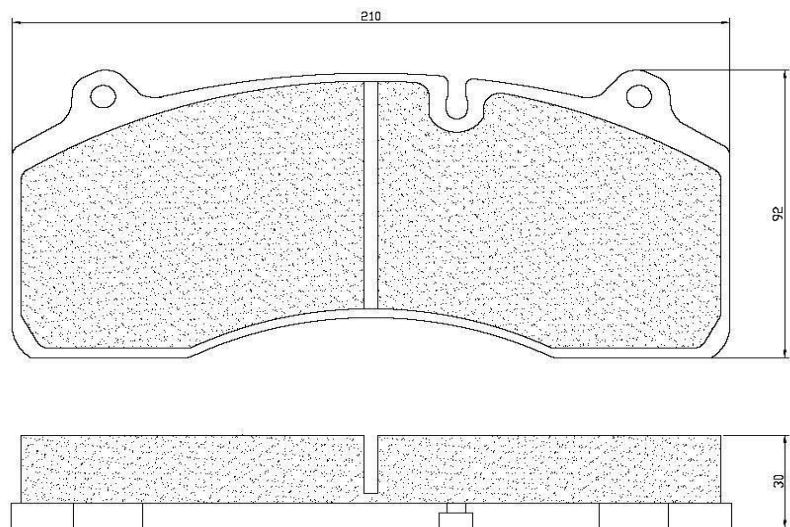

A:210 mm B:92 mm C:30 mm

### KIT

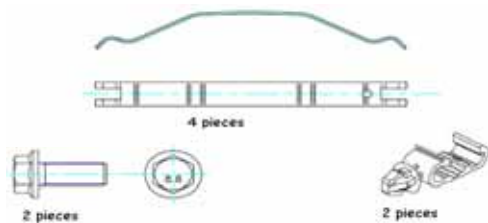

GRANTEX No.: ACK-112

### SPRING

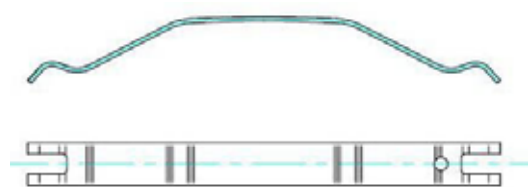

GRANTEX No.: ACC-818

### SENSORS - WEAR INDICATORS

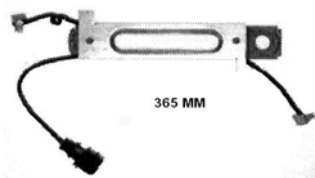

GRANTEX No.: ACC-473

O.E. No.: -

MODELS: RENAULT MIDLUM HLDX, VOLVO FL280 HLDX

GRANTEX No.:

O.E. No.: -

MODELS:

Manufacturers' names and numbers are used for reference purposes only and do not imply any connection with the original manufacturers. All parts in this catalogue are made on behalf of GRANTEX S.A. and are not original parts.

Lcs B2x60  
WVA : 29835, 29065  
GRANTEX No: PAS - 258

**MERCEDES**

**Models:**

Vario 6..., 8...

**O.E. No:**

001 420 15 20  
002 420 57 20  
002 420 62 20  
003 420 15 20  
003 420 77 20  
004 420 48 20  
669 420 00 20  
669 420 01 20  
670 420 28 20

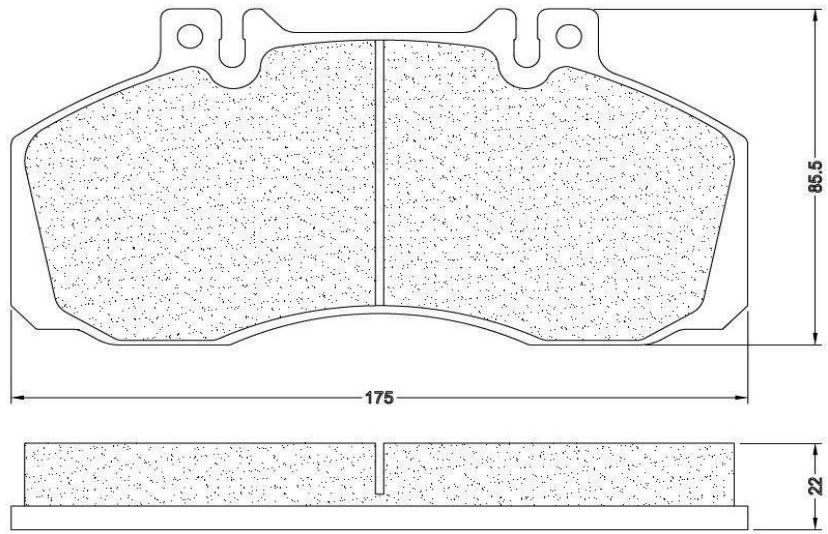

A:175 mm B:85,5 mm C:22 mm

**SENSORS - WEAR INDICATORS**

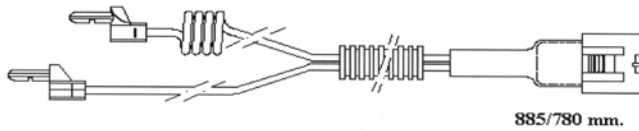

885/780 mm.

**GRANTEX No.:** ACC-423  
**O.E. No.:** 68320874, 68320909 / 969900222  
**MODELS:** RENAULT MIDLINER M/S

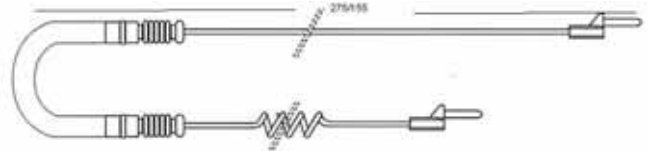

**GRANTEX No.:** ACC-422  
**O.E. No.:** 6695400517/969900122  
**MODELS:** MERCEDES T2/0-SERIES , VARIO , T2/VARIO , MEDIO , LK-SERIES/0-SERIES

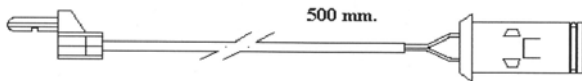

500 mm.

**GRANTEX No.:** ACC-430  
**O.E. No.:** 9801907942  
**MODELS:** IVECO

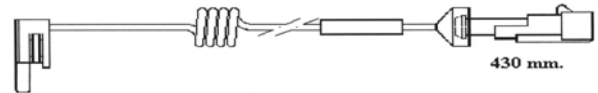

430 mm.

**GRANTEX No.:** ACC-434  
**O.E. No.:** 1908231  
**MODELS:** IVECO



138 mm

**GRANTEX No.:** ACC-474  
**O.E. No.:** 1906462  
**MODELS:** IVECO EUROCARGO 65E-75E



500 mm

**GRANTEX No.:** ACC-469  
**O.E. No.:** 4044197285006  
**MODELS:** IVECO EUROCARGO

Manufacturers' names and numbers are used for reference purposes only and do not imply any connection with the original manufacturers. All parts in this catalogue are made on behalf of GRANTEX S.A. and are not original parts.

WVA : 29122  
GRANTEX No: PAS - 549

IVECO  
Models:  
EuroCargo 65 - 120  
O.E. No:  
190 6416

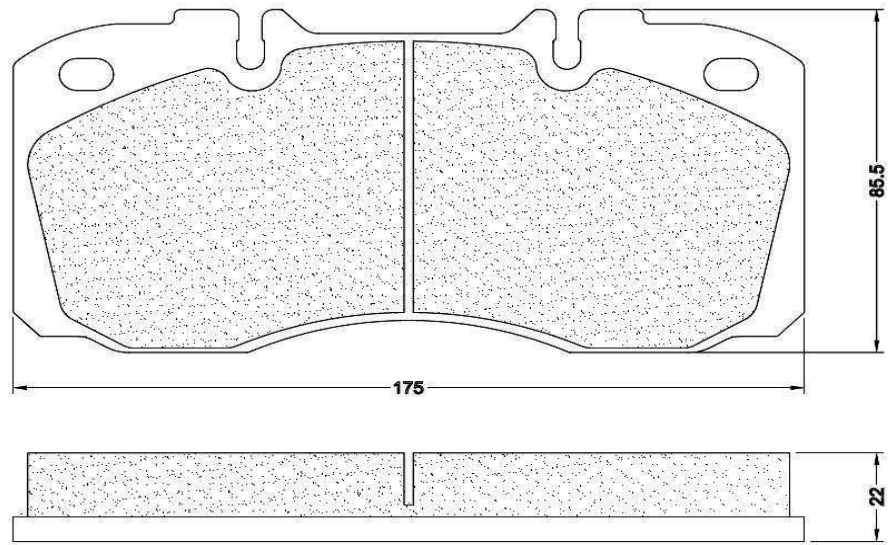

A:175 mm B:85,5 mm C:22 mm

### KIT

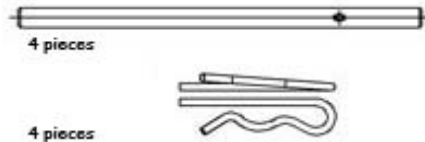

GRANTEX No.: ACK-116

### SPRING



GRANTEX No.: ACC-820

### SENSORS - WEAR INDICATORS

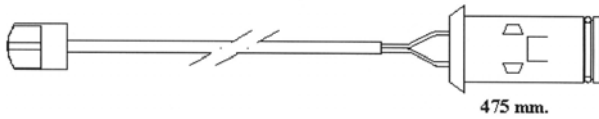

GRANTEX No.: ACC-421  
O.E. No.: 1908825/96990 0250  
MODELS: **IVECO** EUROCARGO

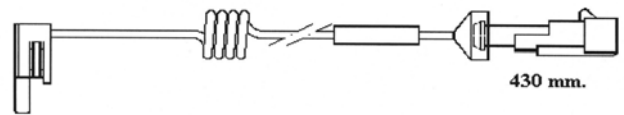

GRANTEX No.: ACC-413  
O.E. No.: 1908231  
MODELS: -

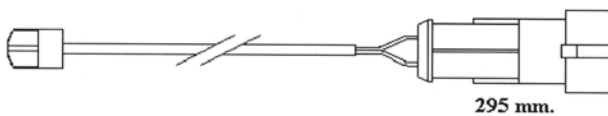

GRANTEX No.: ACC-420  
O.E. No.: 1908407/96990 0248  
MODELS: -

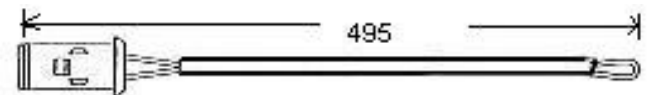

GRANTEX No.: ACC-435  
O.E. No.: 1907942  
MODELS: -

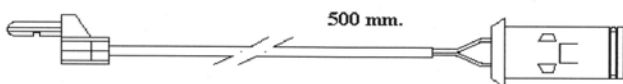

GRANTEX No.: ACC-430  
O.E. No.: 9801907942  
MODELS: -



GRANTEX No.: ACC-475  
O.E. No.: 2992393, 42548195  
MODELS: **IVECO DAILY III 60C14**



### SENSORS - WEAR INDICATORS

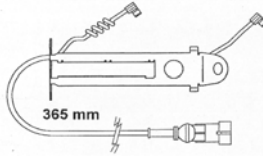

**GRANTEX No.:** ACC-471  
**O.E. No.:** 4044197228669  
**MODELS:** IVECO EUROCARGO

Manufacturers' names and numbers are used for reference purposes only and do not imply any connection with the original manufacturers. All parts in this catalogue are made on behalf of GRANTEX S.A. and are not original parts.

**GRANTEX S.A.** Terma Orpheos, Aegaleo 122 41, Athens - Greece, Tel: +30 210 3473869, Fax: +30 210 3472185, email: [info@grantex.gr](mailto:info@grantex.gr) , url: [www.grantex.gr](http://www.grantex.gr)

MER DX 195  
 WVA : 29124  
 GRANTEX No: PAS - 544  
 ROR  
 MERITOR  
 O.E. No:  
 MDP5076  
 000 421 07 10

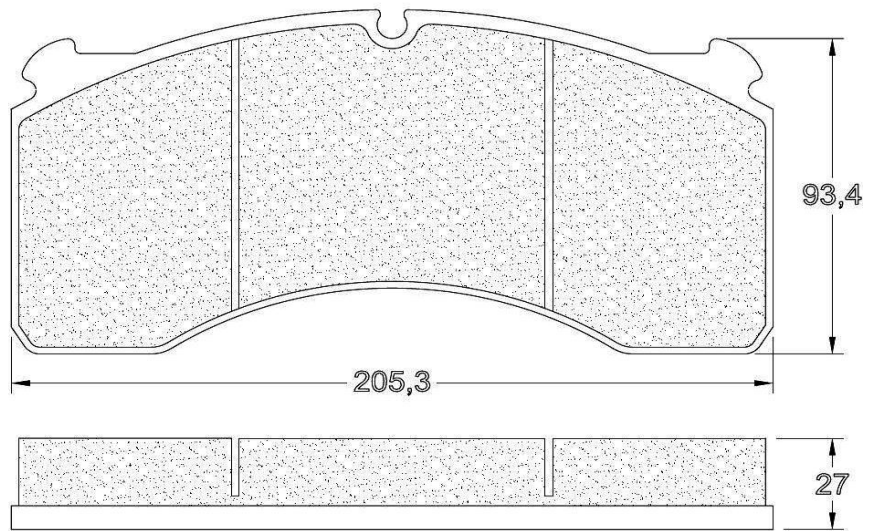

A:205,3 mm B:93,4 mm C:27 mm

### KIT

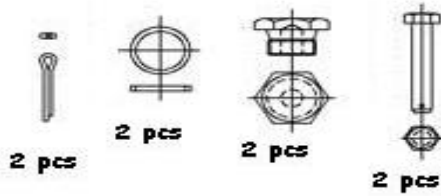

GRANTEX No.: ACK-110

### SPRINGS



GRANTEX No.: ACC-808

### SENSORS - WEAR INDICATORS



GRANTEX No.: ACC-428

O.E. No.: -  
 MODELS: MERITOR

GRANTEX No.: -

O.E. No.: -  
 MODELS: -

Manufacturers' names and numbers are used for reference purposes only and do not imply any connection with the original manufacturers. All parts in this catalogue are made on behalf of GRANTEX S.A. and are not original parts.

**BNDX**  
**WVA : 29011**  
**GRANTEX No: PAS - 453**

**IVECO**  
**Models:**  
 EuroStar LD190 - LD440  
 EuroCargo ...  
 000 421 07 10

**O.E. No:**  
 190 6191  
 190 6459  
 299 2479

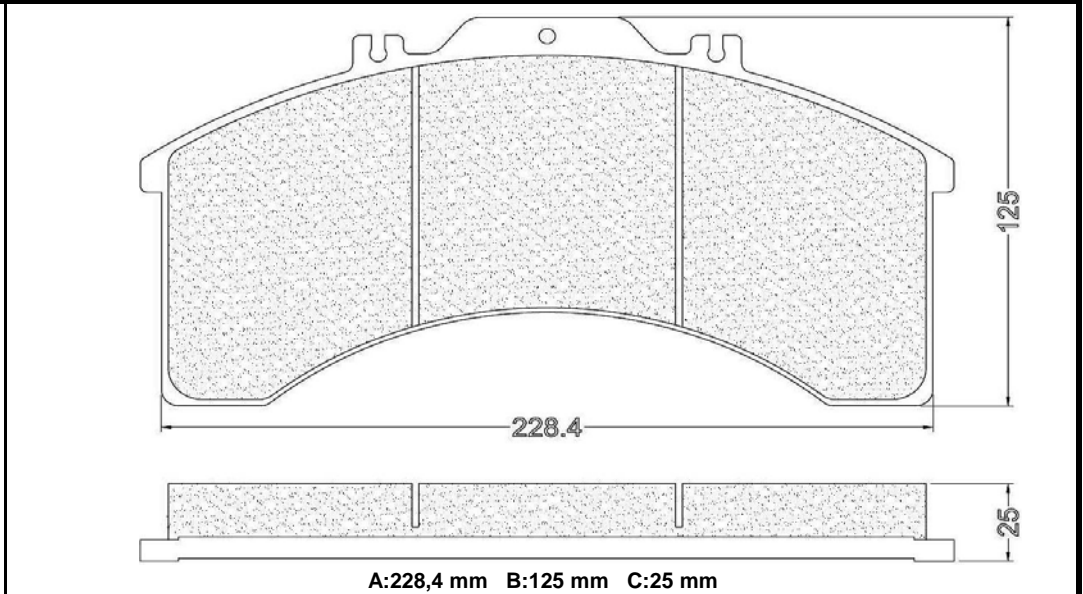

### SENSORS - WEAR INDICATORS

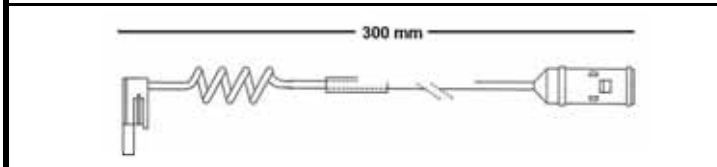

**GRANTEX No.:** ACC-414  
**O.E. No.:** 1907956  
**MODELS:** IVECO EUROCARGO,EUROSTAR,EUROTECH

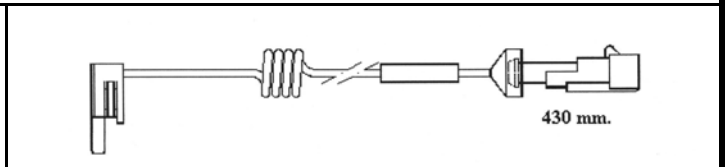

**GRANTEX No.:** ACC-434  
**O.E. No.:** 1908231  
**MODELS:** IVECO EUROCARGO, EUROSTAR, EUROTECH

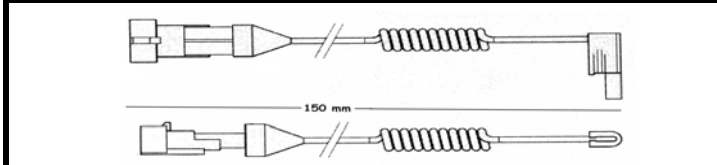

**GRANTEX No.:** ACC-463  
**O.E. No.:** 3284790086889  
**MODELS:** PREMIER



**GRANTEX No.:** -  
**O.E. No.:** -  
**MODELS:** -

Manufacturers' names and numbers are used for reference purposes only and do not imply any connection with the original manufacturers. All parts in this catalogue are made on behalf of GRANTEX S.A. and are not original parts.

MER C - DUCO  
WVA : 29137  
GRANTEX No: PAS - 555

MERITOR  
VOLVO

Models:

FL 180...

FL 220...

O.E. No:

3 093 532

207 681 15

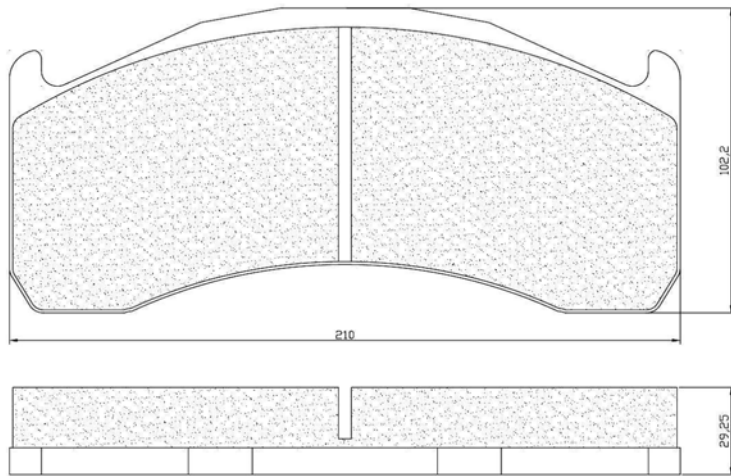

A:210 mm B:102,2 mm C:29,25 mm

### KIT

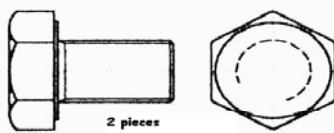

GRANTEX No.: ACK-114

### SPRINGS

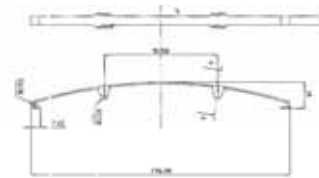

GRANTEX No.: ACC-811

Manufacturers' names and numbers are used for reference purposes only and do not imply any connection with the original manufacturers. All parts in this catalogue are made on behalf of GRANTEX S.A. and are not original parts.

MER B - DUCO  
WVA : 29136  
GRANTEX No: PAS - 556

VOLVO  
Models:  
FL 180...  
O.E. No:  
3 093 531

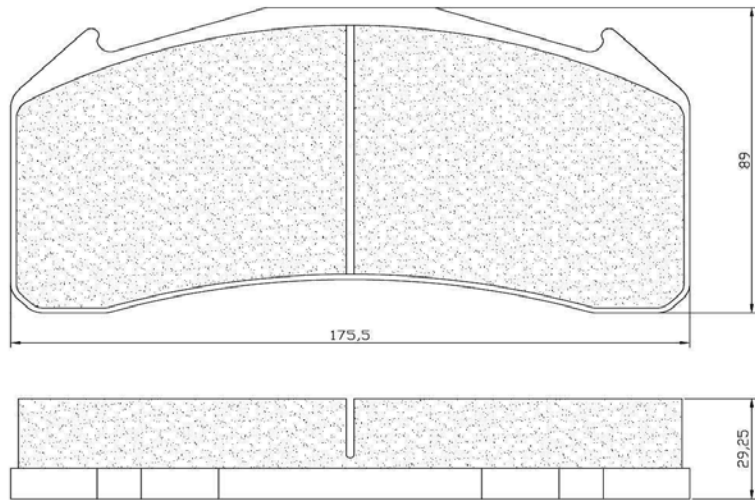

A:175,5 mm B:89 mm C:29,25 mm

### KIT

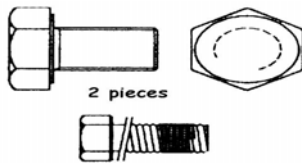

GRANTEX No.: ACK-115

### SPRING

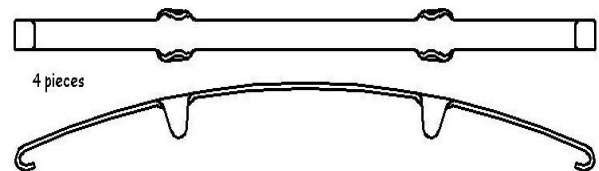

GRANTEX No.: ACC-819

Manufacturers' names and numbers are used for reference purposes only and do not imply any connection with the original manufacturers. All parts in this catalogue are made on behalf of GRANTEX S.A. and are not original parts.

**MER**  
**WVA : 29067**  
**GRANTEX No: PAS - 429**

**RENAULT TRUCKS**  
**Models:**  
 Midliner S120 - S 200  
**O.E. No:**

**VOLVO**  
**IVECO**  
**Models:**  
 EuroCargo 80 - 180  
 Zeta 60 - 109  
**O.E. No:**  
 190 6297

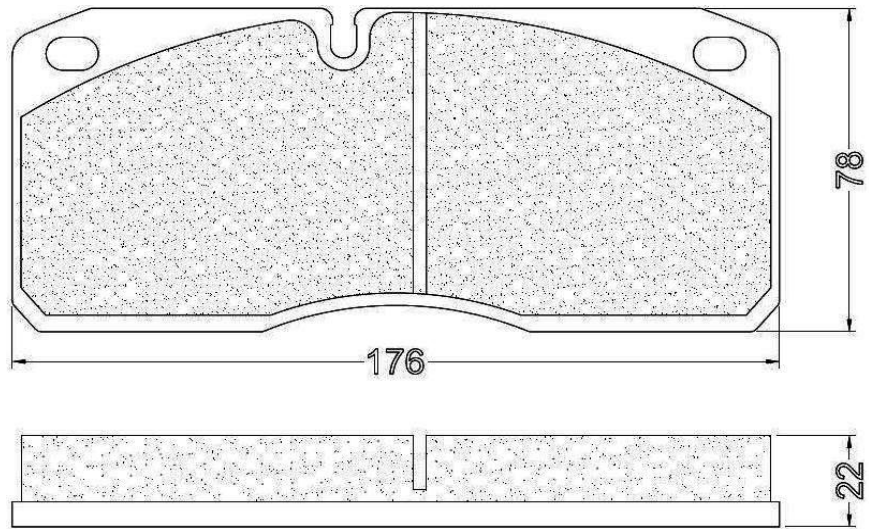

A:176 mm B:78 mm C:22 mm

### KIT

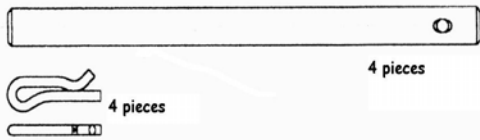

**GRANTEX No.:** ACK-117

### SPRING

**GRANTEX No.:** -

### SENSORS - WEAR INDICATORS

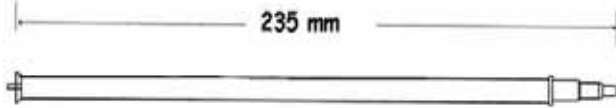

**GRANTEX No.:** ACC-412  
**O.E. No.:** -  
**MODELS:** NISSAN EBRO, VOLVO FL6

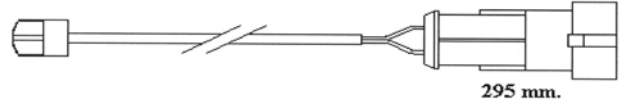

**GRANTEX No.:** ACC-420  
**O.E. No.:** 1908407/969900248  
**MODELS:** IVECO EUROCARGO, DAILY

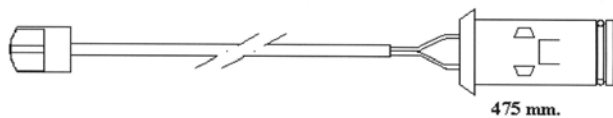

**GRANTEX No.:** ACC-421  
**O.E. No.:** 1908825/969900250  
**MODELS:** IVECO EUROCARGO

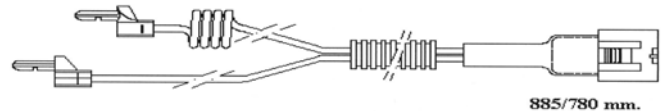

**GRANTEX No.:** ACC-423  
**O.E. No.:** 68320874, 68320909/969900222  
**MODELS:** RENAULT MIDLIMER

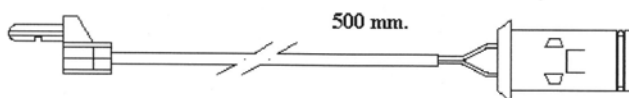

**GRANTEX No.:** ACC-430  
**O.E. No.:** 9801907942  
**MODELS:** -

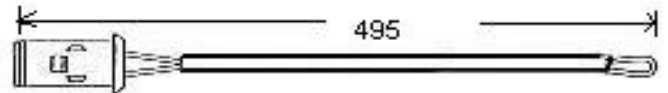

**GRANTEX No.:** ACC-435  
**O.E. No.:** 1907942  
**MODELS:** -

### SENSORS - WEAR INDICATORS

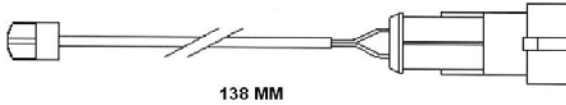

138 MM

**GRANTEX No.:** ACC-474  
**O.E. No.:** 1906462  
**MODELS:** IVECO DAILY



500 MM

**GRANTEX No.:** ACC-469  
**O.E. No.:** 4044197285006  
**MODELS:** IVECO EUROCARGO

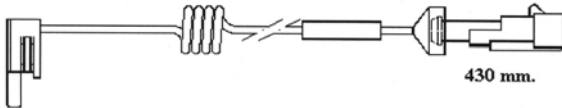

430 mm.

**GRANTEX No.:** ACC-413  
**O.E. No.:** 1908231  
**MODELS:** IVECO SERIES

Manufacturers' names and numbers are used for reference purposes only and do not imply any connection with the original manufacturers. All parts in this catalogue are made on behalf of GRANTEX S.A. and are not original parts.

**GRANTEX S.A.** Terma Orpheos, Aegaleo 122 41, Athens - Greece, Tel: +30 210 3473869, Fax: +30 210 3472185, email: [info@grantex.gr](mailto:info@grantex.gr), url: [www.grantex.gr](http://www.grantex.gr)